

Varenummer: 0118024
 Beskrivelse: Seeger låsering H 10

Mål

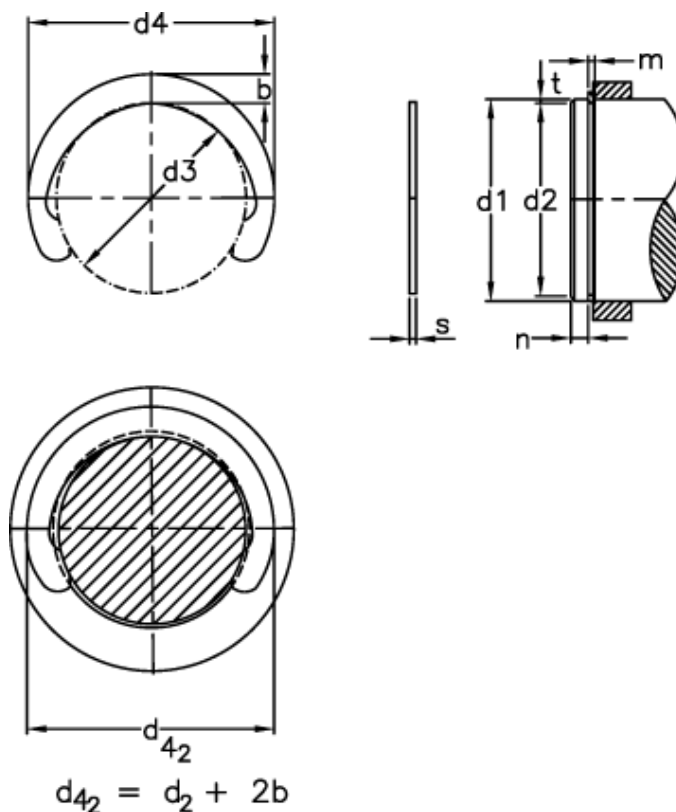

b	= 1.70	FRg kN	= 2.0	t	= 0.50
Betegnelse	= H 10,0	FR kN	= 3.70	tol	= -0.09
d1	= 10	g	= 1.00	tol	= 0.09
d2	= 9.0	Griber	= GRH 10	tol	= -0.06
d3	= 8.75	m min	= 1.10	vægt kg/1000	= 0.26
d4	= 12.15	n abl x 1000	= 50		
d4 2	= 12.4	Nominel træk	= 1.5		
FN kN	= 1.24	s	= 1.00		